

RESOLUTION MSC.362(92)
(Adopted on 14 June 2013)
REVISED RECOMMENDATION ON A STANDARD METHOD FOR
EVALUATING CROSS-FLOODING ARRANGEMENTS

ANNEX 18

RESOLUTION MSC.362(92)
(Adopted on 14 June 2013)

**REVISED RECOMMENDATION ON A STANDARD METHOD FOR
EVALUATING CROSS-FLOODING ARRANGEMENTS**

THE MARITIME SAFETY COMMITTEE,

RECALLING Article 28(b) of the Convention on the International Maritime Organization concerning the functions of the Committee,

RECALLING ALSO resolution A.266(VIII), by which the Assembly, at its eighth session, adopted the *Recommendation on a standard method for establishing compliance with the requirements for cross-flooding arrangements in passenger ships*,

RECALLING FURTHER resolution MSC.245(83), by which it, at its eighty-third session, adopted the *Recommendation on a standard method for evaluating cross-flooding arrangements*,

NOTING that the above *Recommendation on a standard method for evaluating cross-flooding arrangements* needed to be revised and improved, based on recent research results regarding cross-flooding,

RECOGNIZING the need to establish a methodology for evaluating cross-flooding arrangements on ships subject to the applicable subdivision and damage stability requirements of SOLAS chapter II-1 to ensure uniform treatment of cross-flooding and equalization arrangements,

HAVING CONSIDERED, at its ninety-second session, the *Revised Recommendation on a standard method for evaluating cross-flooding arrangements*, prepared by the Sub-Committee on Stability and Load Lines and on Fishing Vessels Safety, at its fifty-fifth session,

1. ADOPTS the *Revised Recommendation on a standard method for evaluating cross-flooding arrangements*, the text of which is set out in the annex to the present resolution;
2. INVITES Governments to apply the annexed Revised Recommendation to ships constructed on or after 14 June 2013 and to bring it to the attention of all parties concerned;
3. NOTES that calculations to evaluate cross-flooding arrangements performed before 14 June 2013 remain valid.

* * *

ANNEX

**REVISED RECOMMENDATION ON A STANDARD METHOD FOR
EVALUATING CROSS-FLOODING ARRANGEMENTS**

Table of contents

1	Definitions
2	Formulae
3	Air pipe venting criteria
4	Alternatives
Appendix 1	Examples for treatment of heel angles and water heads at different stages of cross-flooding
Appendix 2	Friction coefficients in cross-flooding arrangements
Appendix 3	Example using figures for a passenger ship

1 Definitions

Σk : Sum of friction coefficients in the considered cross-flooding arrangement.

s (m^2): Cross-section area of the cross-flooding pipe or duct. If the cross-section area is not circular, then:

$$s_{equiv} = \frac{\pi \cdot D_{equiv}^2}{4}$$

where:

$$D_{equiv} = \frac{4 \cdot A}{p}$$

A = actual cross-section area

p = actual cross-section perimeter

θ_0 ($^\circ$): Angle before commencement of cross-flooding. The cross-flooding device may be assumed to be full or empty dependent on its arrangement and internal volume (see figure 1(b) in appendix 1).

θ_f ($^\circ$): Heel angle at final equilibrium ($\theta_f \leq \theta$).

θ ($^\circ$): Any angle of heel between the commencement of cross-flooding and the final equilibrium at a given time.

W_f (m^3): Volume of water which is used to bring the ship from commencement of cross-flooding θ_0 to final equilibrium θ_f .

W_θ (m^3): Volume of water which is used to bring the ship from any angle of heel θ to the final equilibrium θ_f .

H_0 (m): Head of water before commencement of cross-flooding, with the same assumption as for θ_0 .

H_θ (m): Head of water when any angle of heel θ is achieved.

h_f (m): Final head of water after cross-flooding ($h_f = 0$, when the level inside the equalizing compartment is equal to the free level of the sea).

g (m/s^2): The acceleration due to gravity ($9.81 m/s^2$).

2 Formulae

2.1 Time required from commencement of cross-flooding θ_0 to the final equilibrium θ_f :

$$T_f = \frac{2W_f}{S \cdot F} \cdot \frac{1}{\sqrt{2gH_0}} \cdot \frac{1}{\left(1 + \sqrt{\frac{h_f}{H_0}}\right)}$$

2.2 Time required to bring the ship from any angle of heel θ to the final equilibrium θ_f :

$$T_\theta = \frac{2W_\theta}{S \cdot F} \cdot \frac{1}{\sqrt{2gH_\theta}} \cdot \frac{1}{\left(1 + \sqrt{\frac{h_f}{H_\theta}}\right)}$$

2.3 Time required from commencement of cross-flooding θ_0 until any angle of heel θ is achieved:

$$T = T_f - T_\theta$$

2.4 Dimensionless factor of reduction of speed through an equalization device, being a function of bends, valves, etc. in the cross-flooding system:

$$F = \frac{1}{\sqrt{(\sum k_i) + 1}}$$

Values for k can be obtained from appendix 2 or other appropriate sources such as computational fluid dynamics (CFD) or model testing. If other appropriate sources are used, then the +1 factor in the formulae may not be appropriate. CFD can also be used to evaluate the discharge coefficient for the whole cross-flooding duct.

2.5 Cross-flooding through successive devices of different cross-section:

If the same flow crosses successive flooding devices of cross-section $S_1, S_2, S_3...$ having corresponding friction coefficients $k_1, k_2, k_3...$, then the total k coefficient referred to S_1 is:

$$\sum k = k_1 + k_2 \cdot S_1^2/S_2^2 + k_3 \cdot S_1^2/S_3^2...$$

2.6 If different flooding devices are not crossed by the same volume, each k coefficient should be multiplied by the square of the ratio of the volume crossing the device and the volume crossing the reference section (which will be used for the time calculation):

$$\sum k = k_1 + k_2 \cdot S_1^2/S_2^2 \cdot W_2^2/W_1^2 + k_3 \cdot S_1^2/S_3^2 \cdot W_3^2/W_1^2...$$

2.7 For cross-flooding through devices in parallel that lead to the same space, equalization time should be calculated assuming that:

$$S \cdot F = S_1 \cdot F_1 + S_2 \cdot F_2 + ...$$

With $F = \frac{1}{\sqrt{(\sum k_i) + 1}}$ for each device of cross-section S_i

3 Air pipe venting criteria

3.1 In arrangements where the total air pipe sectional area is 10 per cent or more of the cross-flooding sectional area, the restrictive effect of any air back pressure may be neglected in the cross-flooding calculations. The air pipe sectional area should be taken as the minimum or the net sectional area of any automatic closing devices, if that is less.

3.2 In arrangements where the total air pipe sectional area is less than 10 per cent of the cross-flooding sectional area, the restrictive effect of air back pressure should be considered in the cross-flooding calculations. The following method may be used for this purpose:

The k coefficient used in the calculation of cross-flooding time should take into account the drop of head in the air pipe. This can be done using an equivalent coefficient k_e , which is calculated according to the following formula:

$$k_e = k_w + k_a \cdot (\rho_a / \rho_w) \cdot (S_w / S_a)^2$$

where:

k_w = k coefficient for the cross-flooding arrangement (water)

k_a = k coefficient for the air pipe

ρ_a = air density

ρ_w = water density

S_w = cross-section area of the cross-flooding device (water)

S_a = cross-section of air pipe

4 Alternatives

As an alternative to the provisions in sections 2 and 3, and for arrangements other than those shown in appendix 2, direct calculation using computational fluid dynamics (CFD), time-domain simulations or model testing may also be used.

* * *

Appendix 1

**EXAMPLES FOR TREATMENT OF HEEL ANGLES AND WATER HEADS
AT DIFFERENT STAGES OF CROSS-FLOODING**

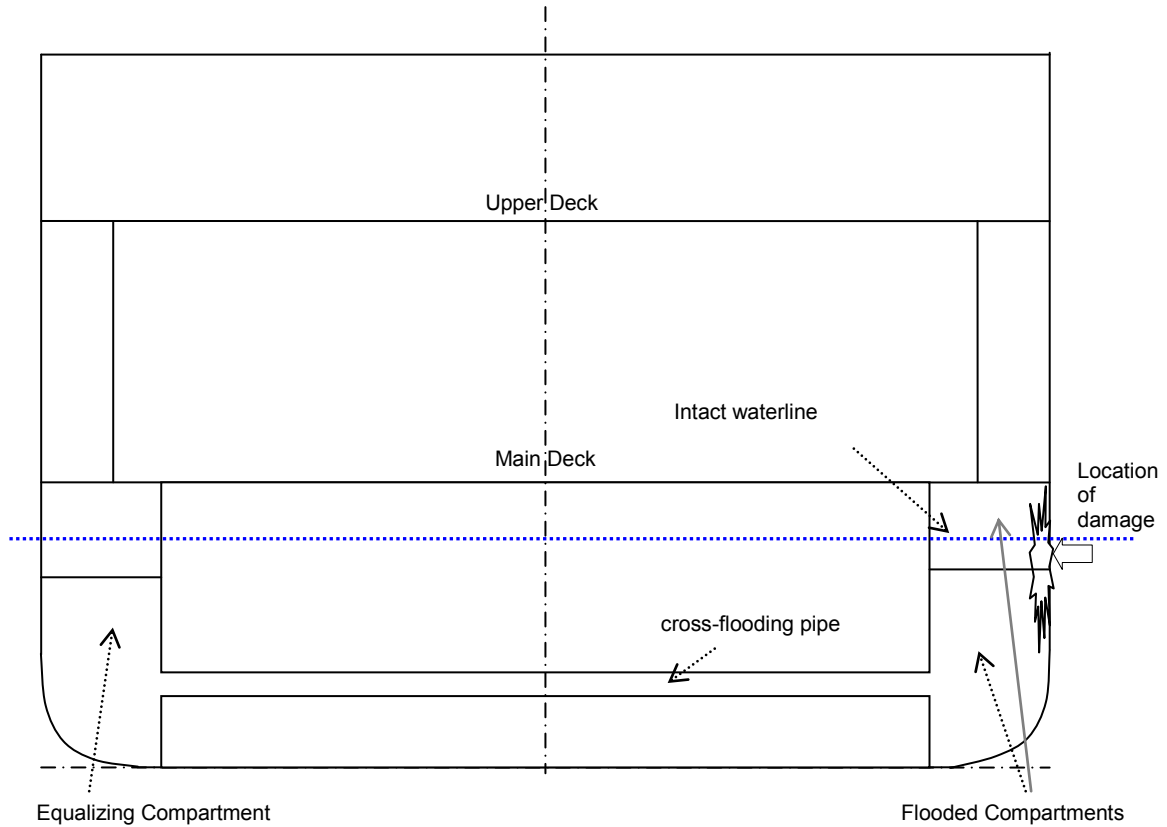

Figure 1(a) – Section showing cross-flooding pipe and compartments

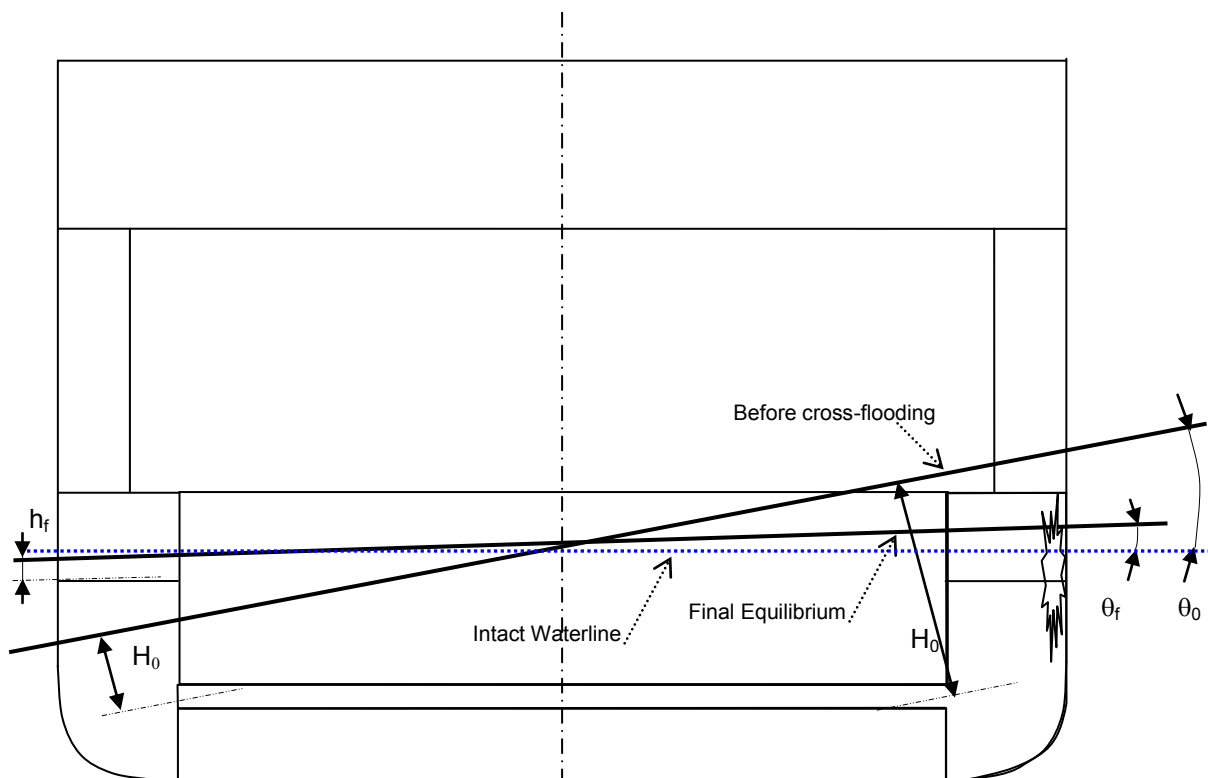

Figure 1(b) – Initial and Final stages of cross-flooding

Note: H_0 on the left side of figure 1(b) depicts the head of water if the cross-flooding device was assumed full whereas H_0 on the right side of figure 1(b) shows the head of water if the cross-flooding device was assumed empty.

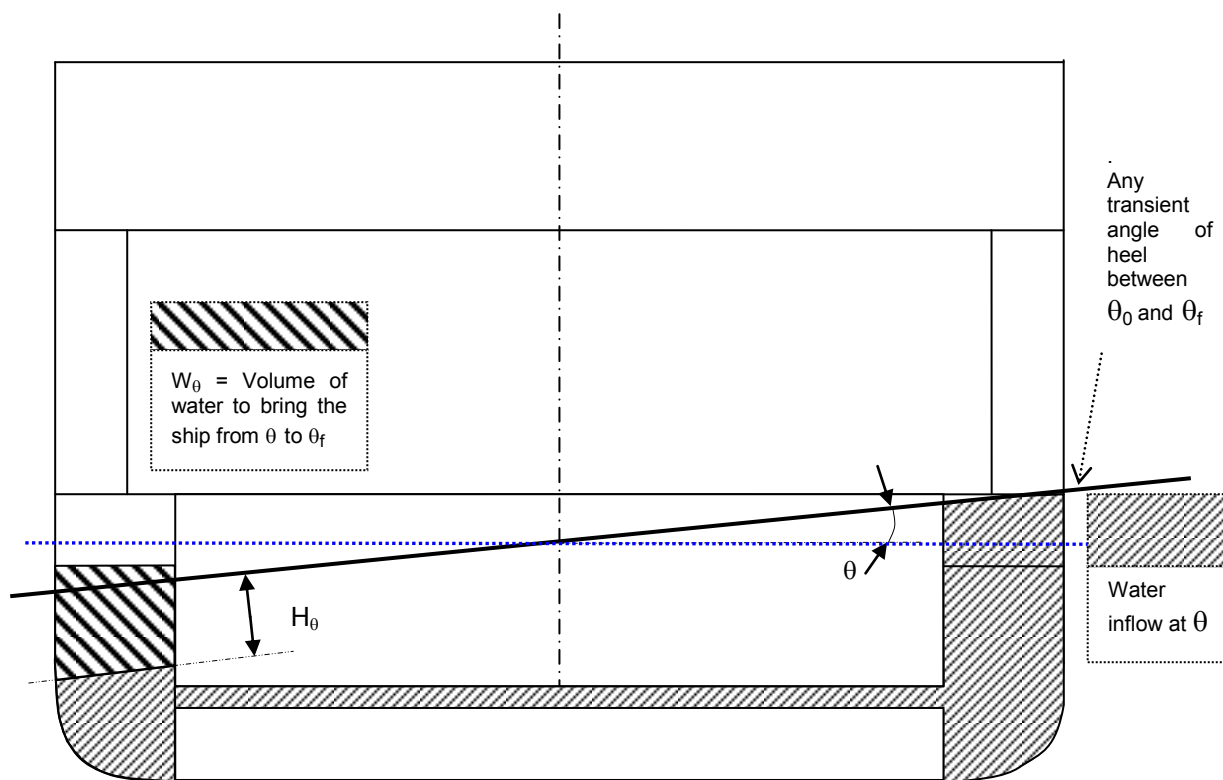

Figure 1(c) – Situation at any transient angle of heel, θ

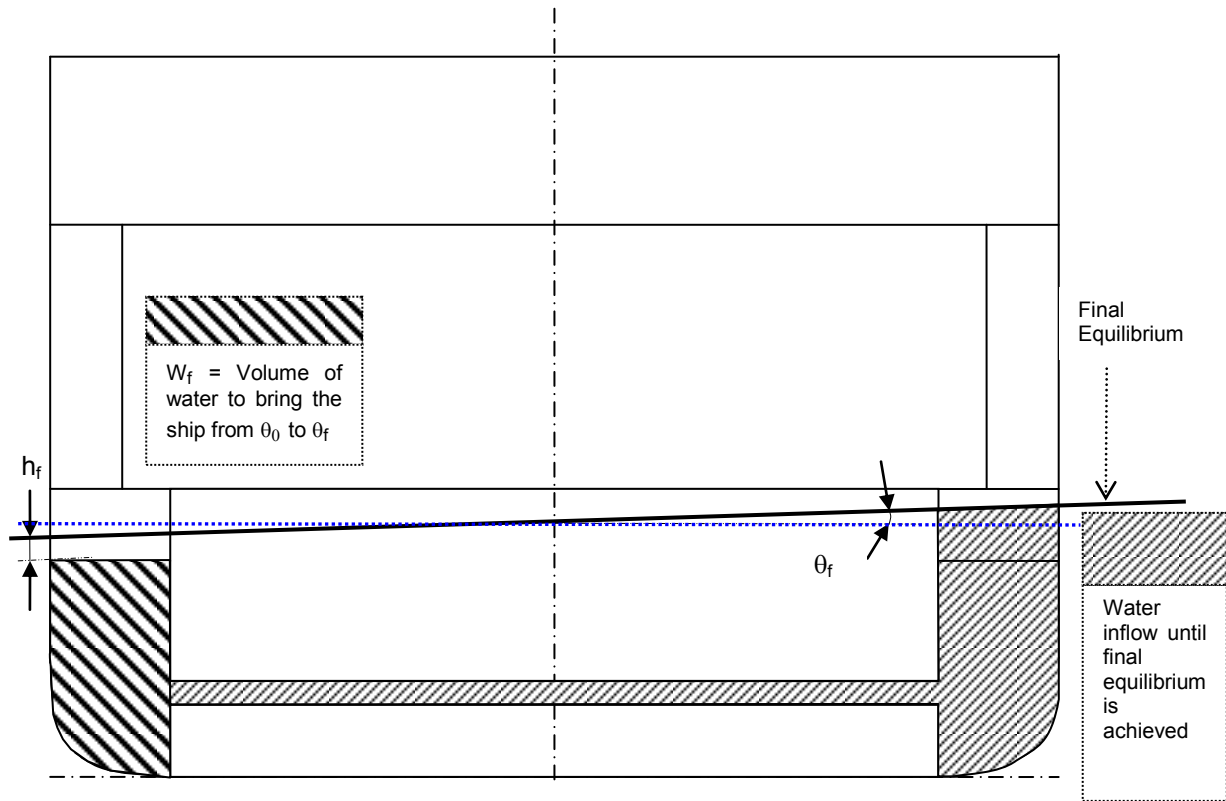
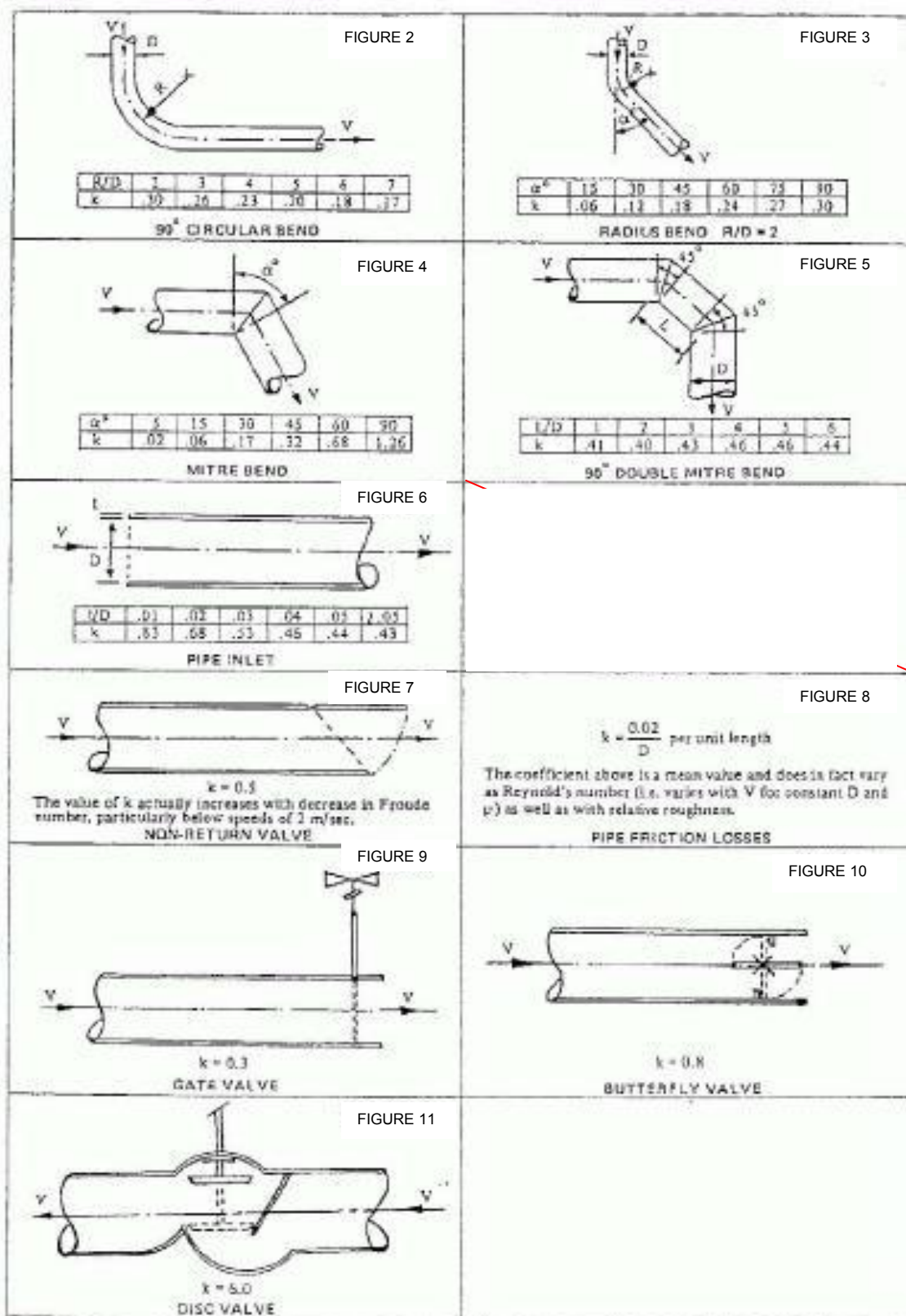

Figure 1(d) – Situation at final equilibrium

* * *

Appendix 2

FRICITION COEFFICIENTS IN CROSS-FLOODING ARRANGEMENTS



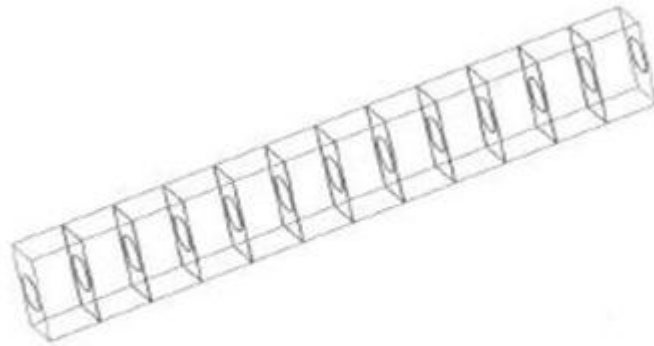

Figure 11
Cross-flooding through a series of structural ducts with 1 manhole

$$k = 0.6718 \times L_i^{0.119} \quad (0 < L_i < 12)$$
$$k = 0.903 \quad (12 \leq L_i)$$

where:

- k friction coefficient related to each space between two adjacent girders
- L_i Length of the duct in meters

Note: k is evaluated with effective cross-section area therefore in calculations use the real cross-section area A and not S_{equiv} . The pressure loss for entrance in the first manhole is already computed in the calculation.

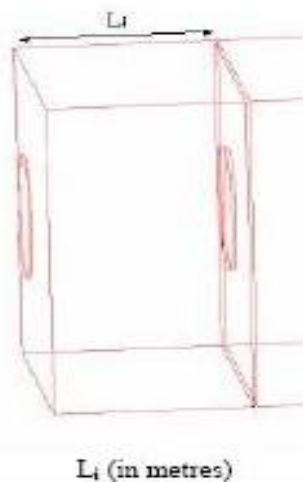

Figure 12

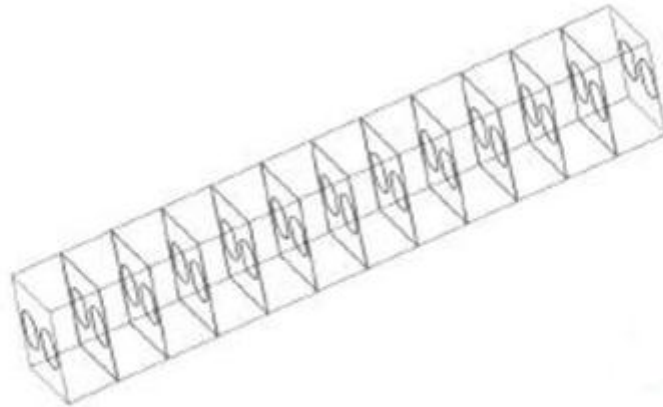

Figure 13
Cross-flooding through a series of structural ducts with 2 manholes

$$k = 1.7968 \times L_i^{-0.026} \quad (0 < L_i < 12)$$
$$k = 1.684 \quad (12 \leq L_i)$$

where:

- | | |
|-------|---|
| k | friction coefficient related to each space between two adjacent girders |
| L_i | Length of the duct in meters |

Note: k is evaluated with effective cross-section area therefore in calculations use the real cross-section area A and not S_{equiv} . The pressure loss for entrance in the first manhole is already computed in the calculation.

* * *

Appendix 3

EXAMPLE USING FIGURES FOR A PASSENGER SHIP

Dimension of the considered cross-flooding pipe:

Diameter	D = 0.39 m
Length	l = 21.0 m
Cross-section area	S = 0.12 m ²
Wall thickness	t = 17.5 mm

k-values for the considered cross-flooding system:

Inlet	0.45
Pipe friction ($\frac{0.02l}{D}$)	1.08
2 radius bends ($\alpha = 45^\circ$)	0.36
Non-return valve	0.50

Sufficient air venting is assumed to be in place.

From this follows:

$$F = \frac{1}{\sqrt{(\sum k_i) + 1}} \qquad F = \frac{1}{\sqrt{3.39}} = 0.54$$

Time required from commencement of cross-flooding θ_0 to the final equilibrium condition θ_f :

$$T_f = \frac{2W_f}{S \cdot F} \cdot \frac{1}{\sqrt{2gH_0}} \cdot \frac{1}{\left(1 + \sqrt{\frac{h_f}{H_0}}\right)}$$

Head of water before commencement of cross-flooding:

$$H_0 = 5.3m$$

Volume of water which is used to bring the ship from commencement of cross-flooding to the final equilibrium condition:

$$W_f = 365m^3$$

Final head of water after cross-flooding:

$$h_f = 1.5m$$

$$T_f = \frac{2 \cdot 365m^3}{0.12m^2 \cdot 0.54} \cdot \frac{1}{\sqrt{2 \cdot 9.81m/s^2 \cdot 5.3m}} \cdot \frac{1}{\left(1 + \sqrt{\frac{1.5m}{5.3m}}\right)}$$

$$T_f = 721s$$

Calculation of any transient situation of cross-flooding:

The purpose is to find the situation after 600s.

Assumed transient situation:

Cross-flooded volume: 265 m³

Volume of water which is used to bring the vessel from the transient situation to the final equilibrium : $W_\theta = 365 \text{ m}^3 - 265 \text{ m}^3 = 100 \text{ m}^3$

Corresponding head of water: $H_\theta = 2.8 \text{ m}$

Time required to bring the vessel from any transient situation to the final equilibrium condition:

$$T_\theta = \frac{2W_\theta}{S \cdot F} \cdot \frac{1}{\sqrt{2gH_\theta}} \cdot \frac{1}{\left(1 + \sqrt{\frac{h_f}{H_\theta}}\right)}$$

$$T_\theta = \frac{2 \cdot 100m^3}{0.12m^2 \cdot 0.54} \cdot \frac{1}{\sqrt{2 \cdot 9.81m/s^2 \cdot 2.8m}} \cdot \frac{1}{\left(1 + \sqrt{\frac{1.5 \approx m}{2.8 \approx m}}\right)}$$

$$T_\theta = 240 \text{ s}$$

Time between commencement of cross-flooding and assumed transient situation:

$$T = T_f - T_\theta = 721 \text{ s} - 240 \text{ s} = 481 \text{ s}$$

As T is less than 600 s, further transient situations with larger cross-flooded volume may be calculated in the same way.

On the reverse, if T was of more than 600 s, further transient situation with smaller cross-flooded volume may be calculated.

Situation after 600 s may be found by successive iterations.

RESOLUTION MSC.362(92)
(Adopted on 14 June 2013)
REVISED RECOMMENDATION ON A STANDARD METHOD FOR
EVALUATING CROSS-FLOODING ARRANGEMENTS